

iSurfa-300 Roughness Waviness Tester



Video



Contact us

Mikrosize Precision Instrument Co.,Ltd

A-4035 RuiFeng Business Expo, Wuhu City, China , 241000.

Web: www.mikrosize.com

Email: mikrosize@mikrosize.com



Feature and Application

Product Feature

- High precision large stroke guide rail, with a length of up to 30mm.
- Sensor range $\pm 500 \mu\text{m}$.
- The all-in-one machine is easy to carry and comfortable to operate.
- Complete parameters, including 5 measurement types and multiple national standards.
- No guide head measurement provides more accurate feedback on the morphology of the machined surface.
- The measuring probe can be directly replaced, making the replacement operation convenient and enabling measurement in different scenarios.
- The sensor can be switched vertically in the same direction as the guide rail, and the depth measurement groove can be made from the side without being limited by the depth of the measuring probe and groove.
- English language and other customized languages.
- Convenient data storage, can be directly stored in the built-in memory of the machine.
- Analysis and calculation including multiple filtering methods can be freely combined to meet requirements.
- Support automatic multiple calibration of standard blocks, greatly reducing errors in calibration.

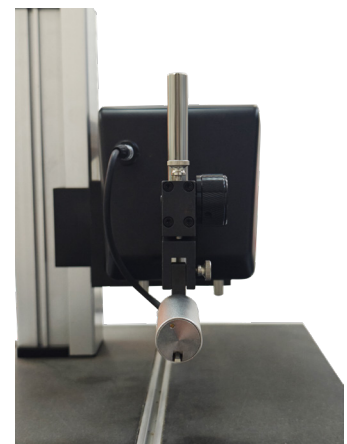

Product Application

- Mechanical processing industry, used to detect the surface roughness and waviness of metal parts after processing, such as shafts, gears, molds, etc., to ensure that the surface quality of the parts meets the design requirements
- In materials science research, it is used to analyze the micro geometric shape of material surfaces, study the relationship between material surface characteristics and properties, and provide data support for the development of new materials
- The surface roughness of printed circuit boards (PCB) can affect the soldering quality and electrical performance of electronic components. This device can be used to detect the surface of PCB, ensuring the stability and reliability of circuits

Product Details

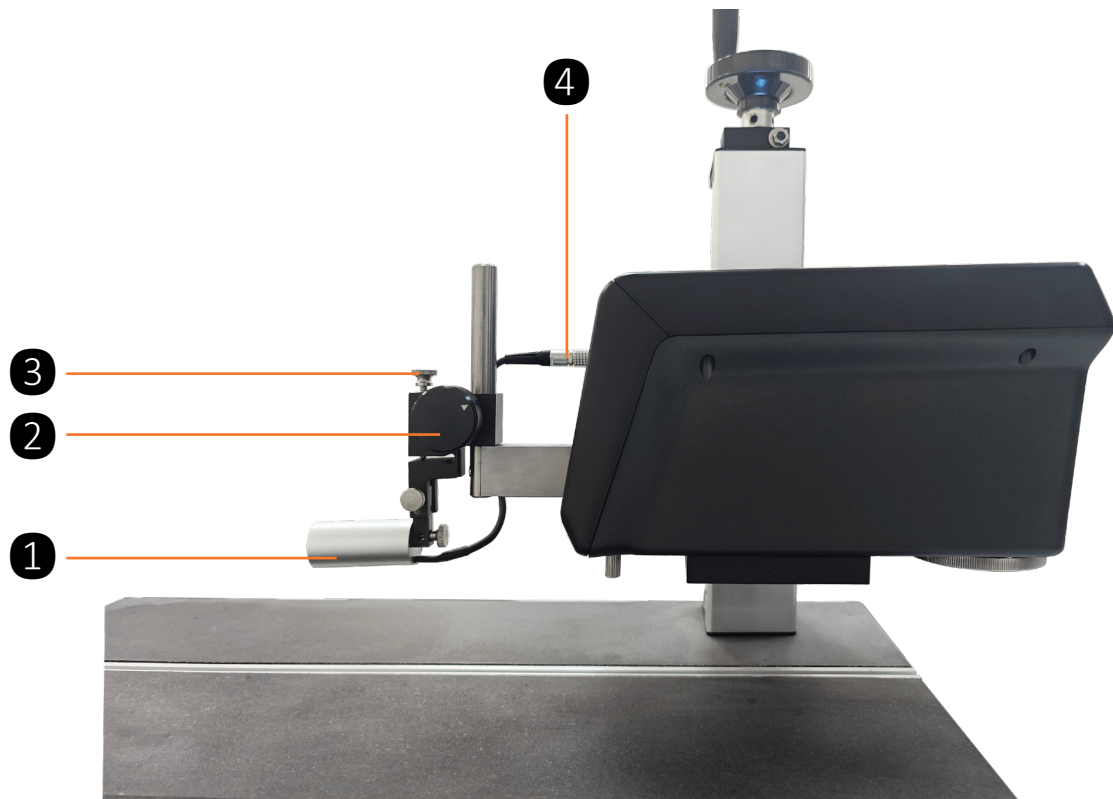

1. Inductance Sensor

2. Sensor Position Adjusting Handwheel

3. Fine Adjusting Of Sensor Position

4. Sensor Interface

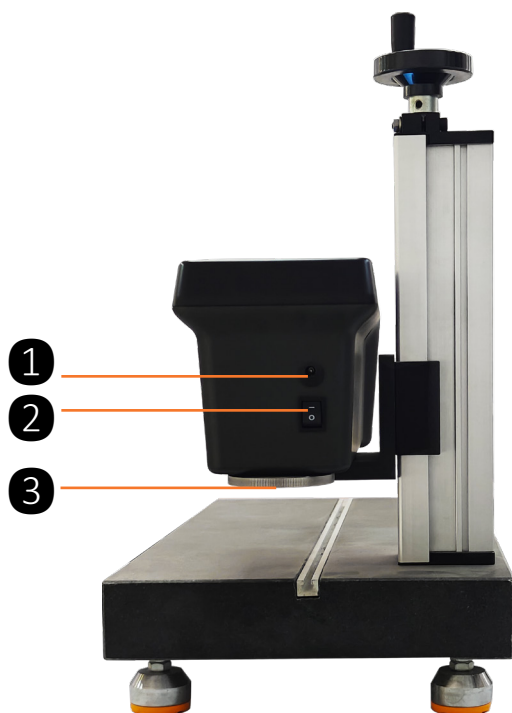

1. Charging Interface

2. Power Switch

3. Horizontal Adjustment Wheel

Operation Interface

Instrument Appearance



1.Power On/Off
5.Stop Key

2.Left Key
6.Display Screen

3.Right Key

4.Start Key

Operation Interface

Instrument Details



- When installing the sensor, align the probe with the sensor rod and push it in, so that the spring plate on the probe is clamped in the corresponding position. Then install the sensor into the lifting and adjusting mechanical part and tighten it with the matching screws.



- When the device is in use, the actuator and the measured surface should be kept relatively parallel to ensure that the sensor does not exceed the range during the measurement process, in order to ensure the accuracy of the measured value and the safety of the sensor.
- Users can control the tilt angle of the guide rail through the horizontal adjustment wheel under the actuator to ensure that the measured value does not exceed the measurement range throughout the entire measurement process.

Operation Interface

Measuring Set

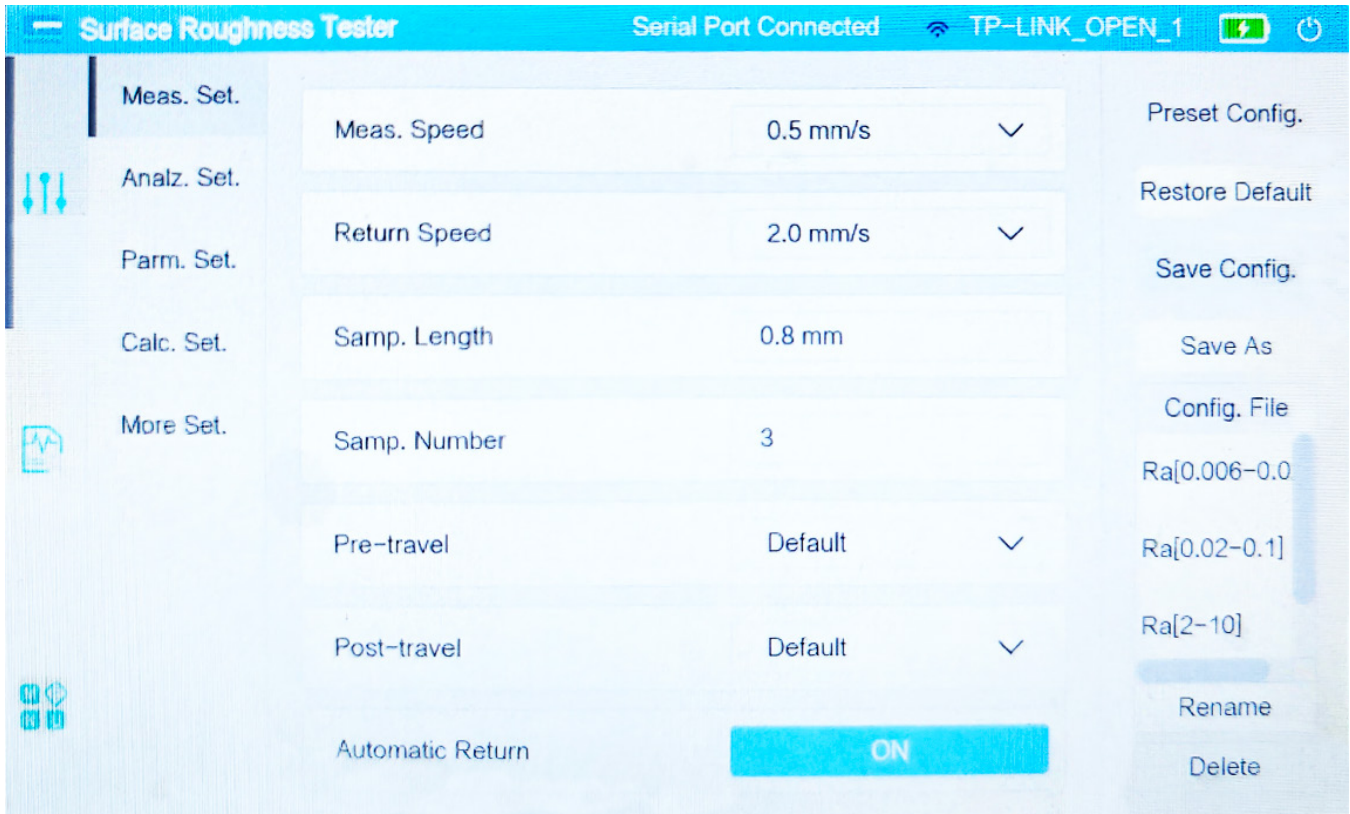

- Selection of measurement speed and return speed.
- Option: 0.05mm/s | 0.10mm/s | 0.50mm/s | 1.00mm/s | 2.00mm/s.
- Select the sampling length sampling numbers.
- Sampling Length: 0.08mm、0.25mm、0.8mm、2.5mm、8mm.
- If the sampling numbers does not exceed the total measurement range, any positive integer can be set, usually 5.
- Set the front and rear spare lengths.
- Options: Default | 1 Sampling Length | 1/2 Sampling Length | 1/3 Sampling Length | 0.
- Suggest users to directly select 'default'
- Turn on and off the automatic return function.
- For ease of use, it is recommended to always enable this feature.

Operation Interface

Analysis Setting

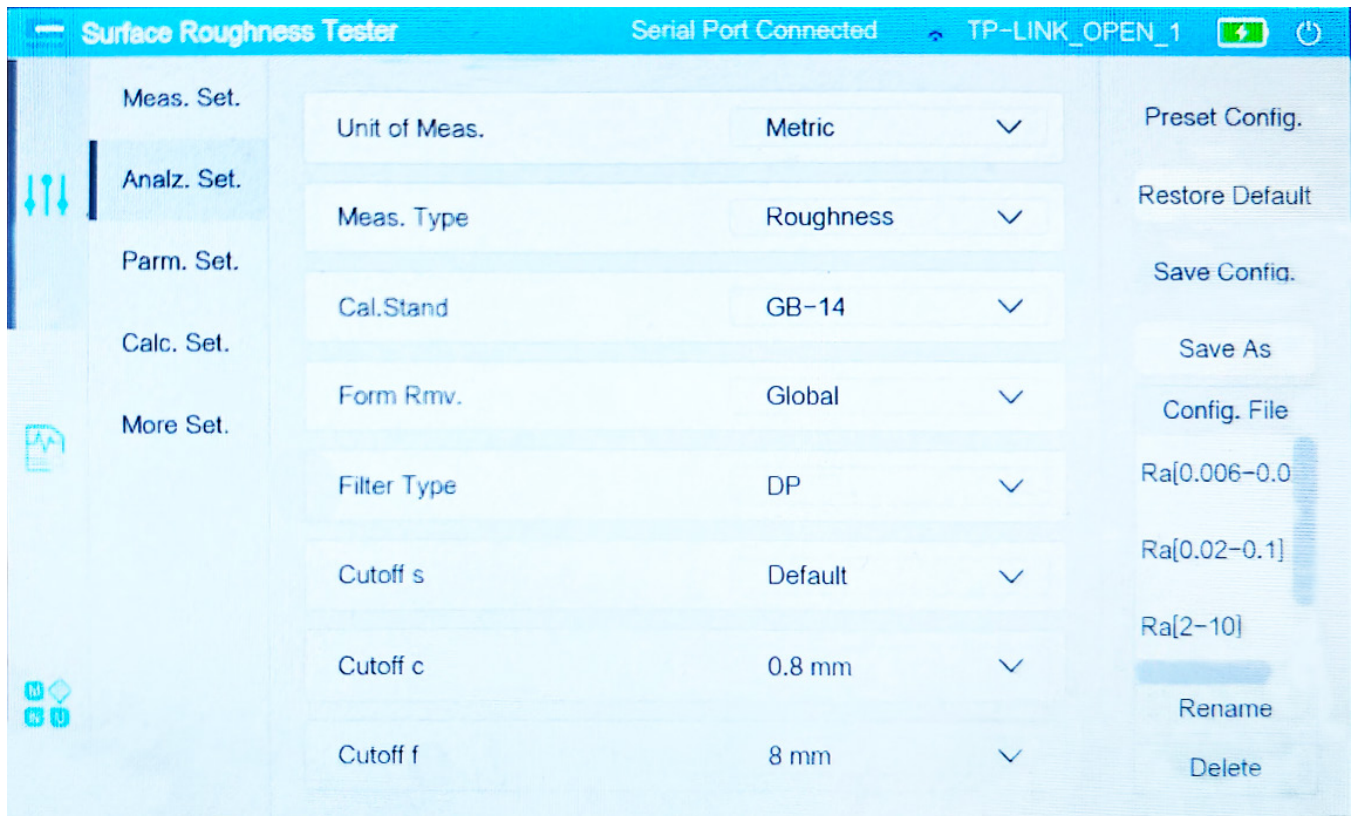

- Selection of measurement units: Metric and Imperial.
- 5 measurement types to choose from.
- Options: Roughness profile | Waviness profile | Primary profile | Bearing-area curve |
- Graphical plot.
- Multiple calculation standards to choose from.
JIS-82 | JIS-87 | JIS-94 | JIS-01 | JIS-13 | ISO-84 | ISO-97 | DIN-90 | ASME-95 | GB-14.
- 6 shapes removed.
- Options: Global | Front Half | Rear Half | Center | 2-point | Curve.
- 5 types of filters.
- Options: Gaussian | FFT | PC | DP | 2RC.
- Cut-off wavelength selection – the wavelength used as the basis for the digital filtering algorithm.
- λ_s options: Default | 0 μm | 2.5 μm | 8 μm | 25 μm .
- λ_c options: 0.08 mm | 0.25 mm | 0.8 mm | 2.5 mm | 8 mm.
- λ_f options: 0.8 mm | 2.5 mm | 8 mm | 25 mm.

Operation Interface

Parameters Setting

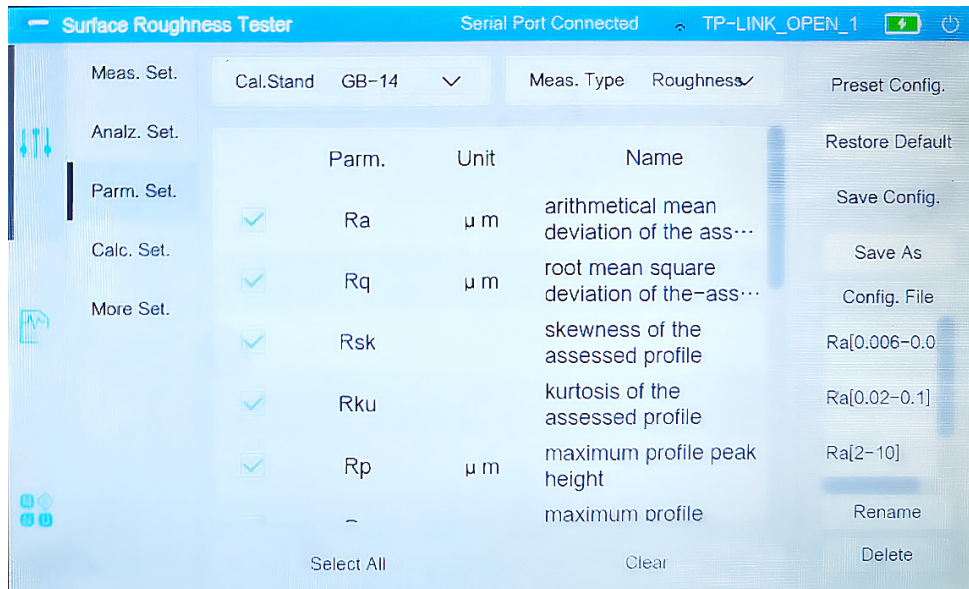

- Users can select appropriate calculation standards and required measurement types on this interface, select the parameters to be displayed, and note that some measurement types may not exist under certain national standards.

Calculation Settings

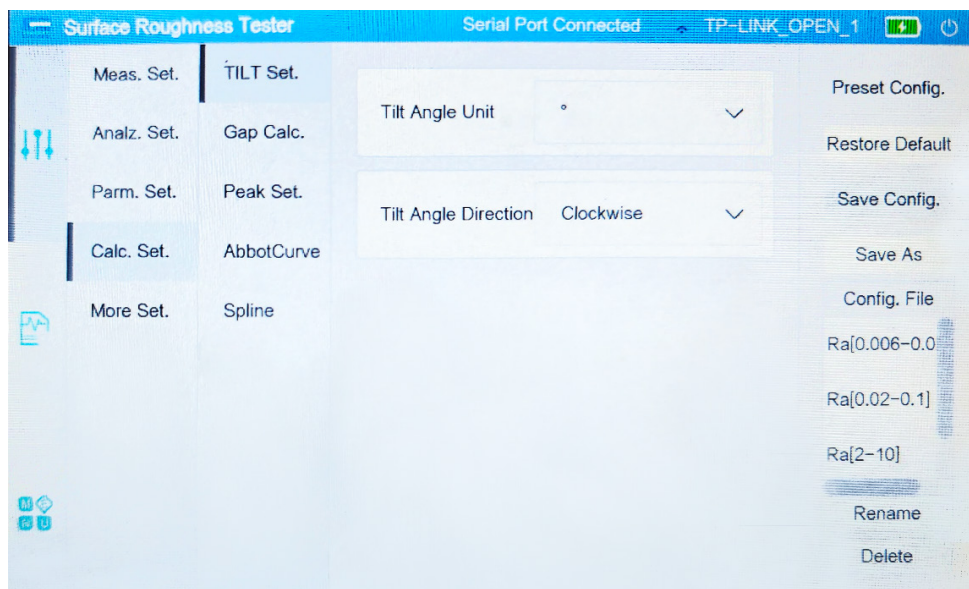

- This interface allows users to set and modify 5 calculation parameters (tilt angle, notch, peak number, support rate curve, spline curve)

Operation Interface

Preset Configuration



- Choose between two types of measuring probes: 40mm and 80mm.
- Select measurement range, options: $\pm 500 \mu m$ | $\pm 25 \mu m$.
- For the convenience of users, there is a one click restore default parameter function on the right side of the screen, which can restore the above parameters to their default values.
- For parameter configurations that need to be used multiple times, the configuration file can be saved and named, and can be called directly the next time it is used without the need for repeated settings.

Operation Interface

Calibration

The screenshot displays the 'Surface Roughness Tester' software interface. At the top, it shows 'Serial Port Connected' and 'TP-LINK_OPEN_1'. The main section is titled 'Calibration' and includes a 'Current Record' field with the following data: File Name: 2024.12.23.0001, Time: 2024-12-23 10:18:54, Parm.: Ra, Value: 3.44, Times: 2. Below this is a 'Recalibrate' section with a dropdown menu set to 'Ra', a 'Value' field set to '3.44', a unit selector set to 'μ m', and a 'Meas. Times' field set to '2'. A large blue 'Start' button is positioned to the right of these fields. At the bottom, there is a 'Records' table with the following data:

Num.	File Name	Time	Parm.	Value	Times	Operations
1	2023.09.16.0001	2023-09-16 09:46:24	Ra	3	2	✗ 📝 🗑️
2	2023.11.02.0001	2023-11-02 13:24:28	Ra	3.03	2	✗ 📝 🗑️

- Calibration Process:
- 1. In the parameter settings, set the measurement type to "Roughness profile".
- 2. Select "Ra" for the calibration standard block.
- 3. Enter the certified Ra value of the calibration block.
- 4. Set the number of measurement passes (1–5).
- 5. Click "Start Calibration".
- 6. After the measurement is complete, save the calibration data and designate this record as the active calibration.

Operation Interface

Data Saving

Surface Roughness Tester Serial Port Connected TP-LINK_OPEN_1

Data Management

Details Rename Print Delete Clear 1 Jump

Num.	File Name	Meas. Type	Cal.Stand	Filter Type	Meas. Time	Workpiece
1	--.12.12.0001	Roughness	GB-14	DP	2024-12-12 17:01:56	--

1 Records Page 1 (Total 1 Pages) First Prev Next Last

- This interface allows you to view saved data, including measurement types and time, calculation standards, and filtering types.
- After selecting the data, you can view detailed information, rename or delete the data, and print the selected data if the device is connected to a printer.
- Clicking the clear button will clear all stored data.

Operation Interface

General Setup

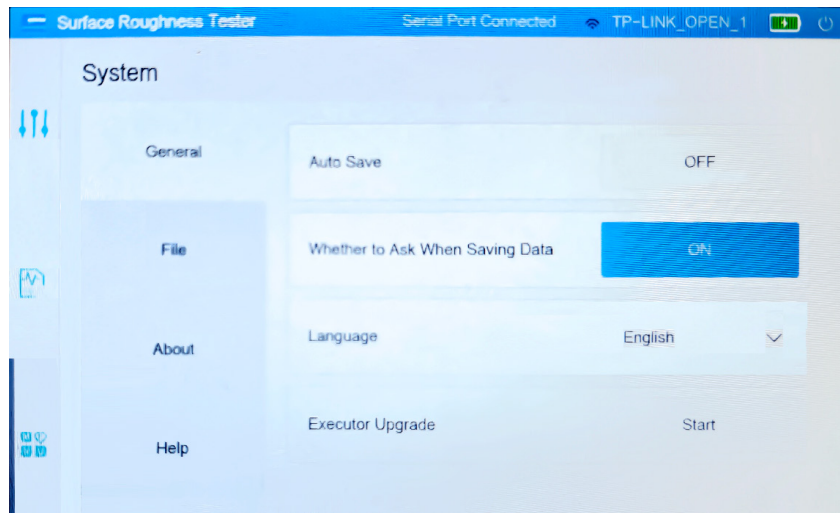

- Auto save: automatically save data after measurement.
- Do you ask when saving data: every time you click save data, you will be asked for save information
- Language switching: Switch between English and other languages

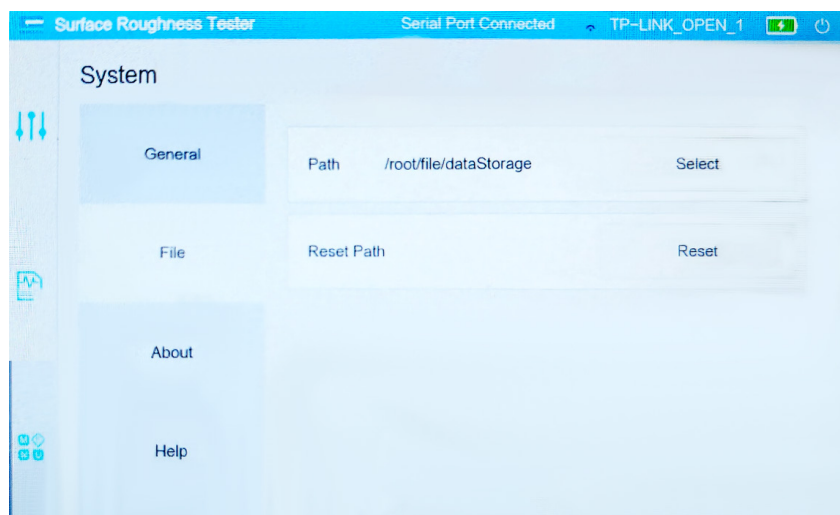

Files Management

- This interface allows you to change the path of data storage and reset the default path of data storage.

WIFI Connecting

- This device has WIFI connection function, which facilitates data management and output printing



Technical Specification

Model	iSurfa-300	
Range	X Direction:300mm/Z Direction:±500µm	
Resolution	X Direction:0.0016µm/±50µm-0.016µm/±500µm	
Straightness	1µm/30mm	
Parameters	Roughness Profile	Ra75,Rq,Rp,Rv,Rc,Rt,S,R3z,PPI,Ra,Rsk,Rku,Ry,Sm,RΔa,RΔq,Rz,Pc,Rλa,Rλq,Ir,RSm,Rz94,RPc,RS,Rz.I,Rpm,HSC
	Waviness Profile	WCA, WCC-q, WCC-p, WCC-v, WCC-m, WCC2Sm, WCA, WC-q, WC2p, WC-v, WCM, WC2Sm, WC-t, Wa, Wq, Wsk, Wku, Wp, Wv, Wz, Wc, Wt, WSm, WΔq, WPc
	Primary Profile	Rsk, Rku, Rmax, Sm, Δa, Δq, Rz, λa, λq, Ir, TILT A, AVH, Hmax, Hmin, AREA, Rz.J, Pa, Pq, Psk, Pku, Pp, Pv, Pc.I, Pt, PSm, PΔq, PPc, Pc
	Abbott Curve	Rk,Rpk,Rvk,Mr1,Mr2,V0,K,A1,A2
	Motif	NCRX,AR,R,Rx,NR,CPM,SR,SAR,AW,W,Wx,Wte,NW,SW,-SAW,Rke,Rpke,Rvke,Mr1,Mr2,V0,K
Evaluation Curve	Roughness profile,Waviness profile,Primary profile,Abbott curve,Motif	
Characteristic Curve	Abbott curve (Rmr(c),Rmr2(c),Rδc(c),tp(c),tp2(c),Ht-p(c)),Amplitude frequency analysis curve,amplitude distribution curve	
Form Remove	Global, first half, second half, center, 2 points, curve	
Filter Type	Gaussian,FFT,PC,DP,2RC	
Filter Wave length	λs	0, 2.5, 8, 25µm
	λc	0.08, 0.25, 0.8, 2.5, 8mm

Technical Specification

Filter Wave length	λf	0.8, 2.5, 8, 25mm
Evaluation Length		Sampling length × number of samples (sampling length has standard mode and custom mode)
Measurement and Return Speed		0.05mm/s, 0.10mm/s, 0.50mm/s, 1.00mm/s, 2.00mm/s
Sensor	Model	Standard Universal Type
	Sensing Method	Differential Inductance
	Range	±500 μ m
	Stylus	5 μ mR diamond 90°
	Contact Force	0.4~0.75mN (Adjustable)
Display Part		10-inch color IPS touch screen
Data Output		PDF/WIFI printing
Power Supply		AC220V±10% Built-in rechargeable battery (AC adapter charging) 3 hours charging time
Power Consumption		30VA
Weight		Net:3Kg Gross:10Kg
Dimension		Main Unit 350(L)×116(W)×146(H)

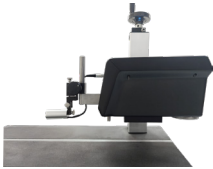
Standard Delivery

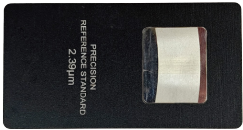
Name	Qty	Photo
Main Unit	1pc	
Sensor	1pc	
Charger	1pc	/
Standard Probe	1pc	
Standard Block	1pc	
Waterproof Main-Unit Case	1pc	/
Hex key (2.5 mm)	1pc	/
Documents	1pc	/

Optional Delivery

Optional

X-Y Cross Slide Stage



Flat Fixture



Marble V-block



Probe



Mikrosize Precision Instrument Co.,Ltd

Add: A-4035 RuiFeng Business Expo , Wuhu City, China , 241000.

Tel: 0553-2836939 Fax:0553-2836938 Web: www.mikrosize.com

Mikrosize®
SINCE 2009
Professional Brand
Manufacturer

MEASURING & TESTING

