



# **iLeeb-300 Portable Hardness Tester**

## **Instruction Manual**



**Anhui Mikrosize Precision Instrument Co.,Ltd**

**Add:** A-4035 RuiFeng Business Expo, Wuhu City, China, 241000.

**Web:** [www.mikrosize.com](http://www.mikrosize.com) **Email:** [mikrosize@mikrosize.com](mailto:mikrosize@mikrosize.com)

# Contents

<b>1.Product Introduction.....</b>	<b>1</b>
<b>2.Technical Parameters.....</b>	<b>3</b>
<b>3.Structural Features and Working Principle.....</b>	<b>4</b>
<b>4.Preparation before Measurement.....</b>	<b>8</b>
<b>5.Measurement Method.....</b>	<b>10</b>
<b>6.Instrument Operation.....</b>	<b>13</b>
<b>7.Maintenance and Repair.....</b>	<b>20</b>
<b>8.Appendix.....</b>	<b>21</b>
<b>9.Packing List.....</b>	<b>25</b>

# 1. Brief Introduction

## 1.1 Features

- Probe automatic identification, plug and play (other manufacturers require users to plug the probe before boot)
- Using Cortex-M0 core high-performance ARM processor as the main control chip, processing speed;
- Unique full-format display, at the main interface, all the standard can be displayed, no need to look up the table, no need to switch;
- Leeb hardness shock wave display, can determine the effectiveness of testing and impact device working conditions, such as whether the probe is worn, whether there is dirt in the casing.
- With USB communication interface, standard with host computer data processing software.
- With Bluetooth Printing Function, Optional Bluetooth Printer. According to the principle of Leeb hardness measurement, a variety of metal materials can be tested.
- The power supply adopts 2 AA (No. 5) size ordinary alkaline batteries, which can work continuously for not less than 50h. It has the functions of automatic dormancy, automatic shutdown and other power-saving functions.
- The instrument is compact, portable, high reliability and suitable for harsh operating environment, anti-vibration, impact and electromagnetic interference.

## 1.2 Main Purpose and Scope of Application

### 1.2.1 Main Purpose

- Mold cavity;
- Bearings and other parts;
- Failure analysis of pressure vessel, steam turbine generator unit and its equipment;

# 1. Brief Introduction

- Heavy workpieces;
- Installed mechanical or permanently assembled parts;
- Workpieces with narrow test space;
- Formal original records of test results are required;
- Material differentiation of metal material warehouse;
- Rapid inspection of multiple measuring parts in a large range of large workpieces.

## 1.2.2 Scope of Application

See attached table 1 and 2 for the scope of application.

## 1.3 Working Conditions

Ambient temperature: operating temperature - 10 °C ~ + 50 °C;

Storage temperature: - 30 °C ~ + 60 °C;

Relative humidity  $\leq$  90%;

There is no strong vibration, strong magnetic field, corrosive medium and serious dust in the surrounding environment.

## 2. Technical Parameters

See the table below for indication error and indication repeatability.

Table 2-1

No.	Impact device Type	Standard Hardness Test Block	Indication error	Indication repeatability
1	D	760±30HLD 530±40HLD	±6 HLD ±10 HLD	6 HLD 10 HLD
2	DC	760±30HLDC 530±40HLDC	±6 HLDC ±10 HLDC	6 HLD 10 HLD
3	DL	878±30HLDL 736±40HLDL	±12 HLDL	12 HLDL
4	D+15	766±30HLD+15 544±40HLD+15	±12 HLD+15	12 HLD+15
5	G	590±40HLG 500±40HLG	±12 HLG	12 HLG
6	E	725±30HLE 508±40HLE	±12 HLE	12 HLE
7	C	822±30HLC 590±40HLC	±12 HLC	12 HLC

- Measurement range: HLD (170 ~ 960);
- Measurement direction: support vertical downward, oblique downward, horizontal, oblique upward and vertical upward;
- Measuring materials: steel and cast steel, alloy tool steel, cast aluminum alloy, gray cast iron, nodular cast iron, stainless steel, copper zinc alloy (brass), copper tin alloy (bronze), pure copper;
- Hardness system: Richter (HL), Brinell (HB), Rockwell B (HRB), Rockwell C (HRC), Vickers (HV), shore (HS);
- Display: color screen;
- Data storage: up to 100 groups (impact times 32 ~ 1);
- Working voltage: 3V (two AA size alkaline batteries in series);
- Continuous working time: Low brightness for about 15 hours; High brightness for about 7 hours;
- Communication interface standard: USB;

# 3. Structural Features and Working Principle

## 3.1 Structural features



1. Impact device socket    2. Impact device    3. Main unit    4. Keyboard    5. Screen

### 3.1.1 D Impact Device

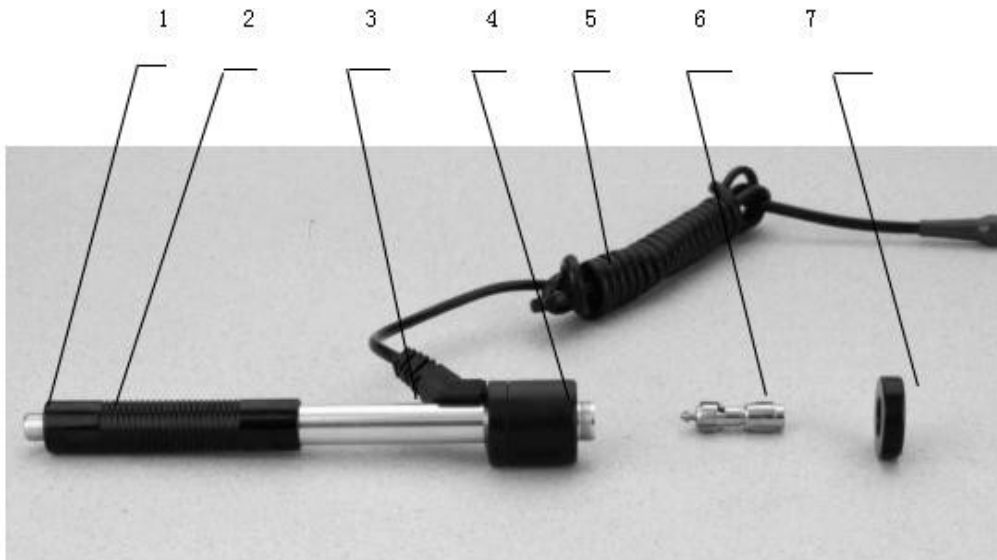

1. release button                      5. wire  
2. loading sleeve                      6. impact body  
3. conduit                                7. support ring  
4. coil part

## 3. Structural Features and Working Principle

### 3.1.2 Special Shaped Impact Device

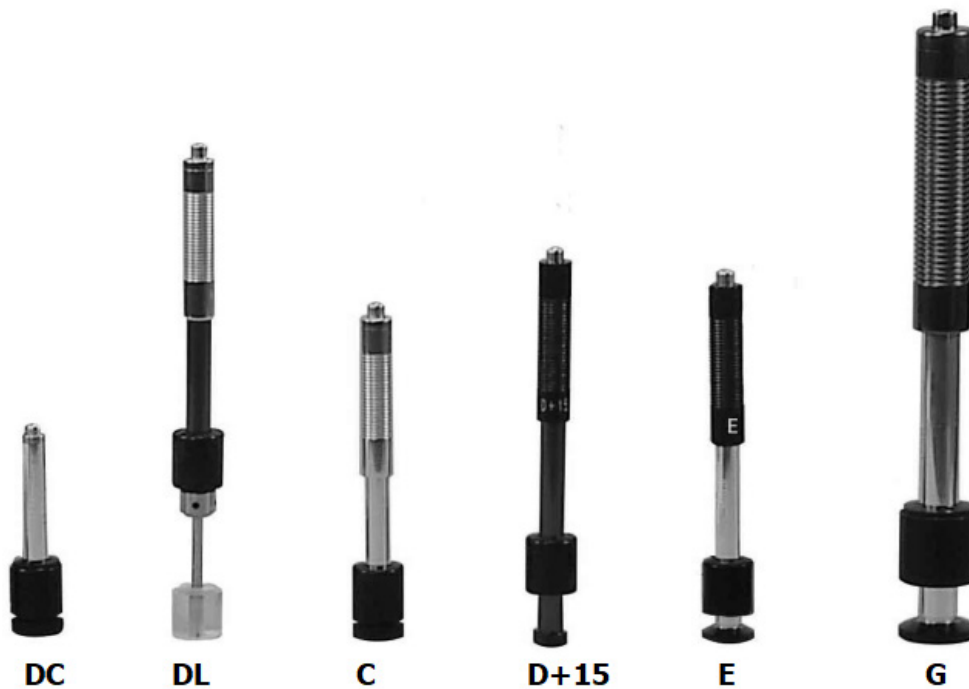

### 3.2 Main Display Interface

After startup, the instrument will automatically enter the main display interface, as shown in the following figure:

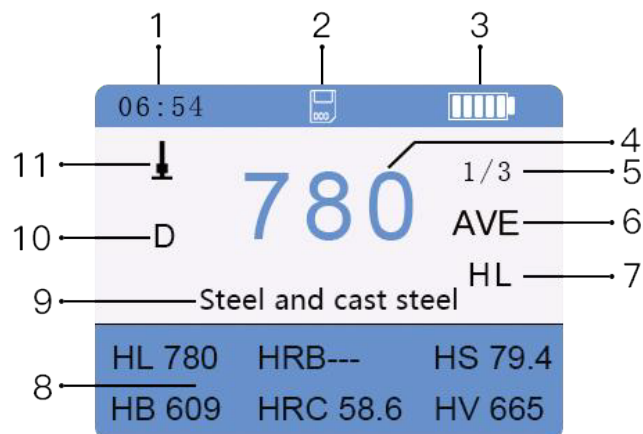

1. Time display

6. Average flag

11. Impact direction

2. Automatic storage Flag

7. Hardness value

3. Battery level display

8. 6 display of hardness system

4. Measured value

9. Material of tested material

5. Number of measurements

10. Impact device type

## 3. Structural Features and Working Principle

### Description of main display interface

**Material:** the currently set material.

**Impact direction:** current impact direction.

**Hardness system:** the hardness system of the current measured value.

**Battery power:** displays the remaining power.









**Measured value:** current single measured value (no average value prompt), current average value (with average value prompt).



The display "- Hi -" indicates that the conversion or measurement range is exceeded, and "- Lo -" indicates that it is lower than the conversion or measurement range.

**Impact times:** the completed impact times are displayed during measurement, and the set impact times are displayed when the impact times are set with the key, Average









**value Icon:** after reaching the set impact times, the average value icon "Ave" appears.

### 3.3 Keyboard Definition

	Material selection		UP / Hardness system selection		Enter menu
	Direction / Left		Data statistics / Down		Save / Right
	Waveform view		Average times setting		On/Off

- Press  the key to change the material setting, and each press will cycle among the materials.
- The hardness system setting can be changed by pressing the  key. Each press will change the current material and impact device circulation between various hardness systems.
- Press  the key to enter the menu mode for various settings.

## 3. Structural Features and Working Principle

- Press  the key to modify the setting of impact times, enter the setting state of [impact times] on time for the first time, and select the box to display the currently set impact times, press  or  set the times, and then exit the setting on time.
- Press  the key to modify the impact direction of the impact device, and each press will cycle between each direction.
- Press  the key to save the measurement data without opening the automatic data saving. The saved data can only be saved when it is the display average value.
- Press  the key to view the statistical table of data measured each time.
- Press  the key to view the impact waveform generated during impact measurement and judge the accuracy of data from the surface. Refer to Section 3.4 working principle
- Press  the key to start / shut down. Generally, it needs to be pressed for 3 seconds to start / shut down.

### 3.4 Working Principle

Impact the surface of the sample at a certain speed with an impact body of specified quality under the action of elastic force, and use a punch to Calculate the hardness value according to the ratio of rebound speed and impact speed at 1mm on the surface. The calculation formula is as follows:

$$HL=1000 \times VB/VA$$

Where:

HL - Leeb hardness value

VB - rebound speed of impact body

VA - impact speed of impactor

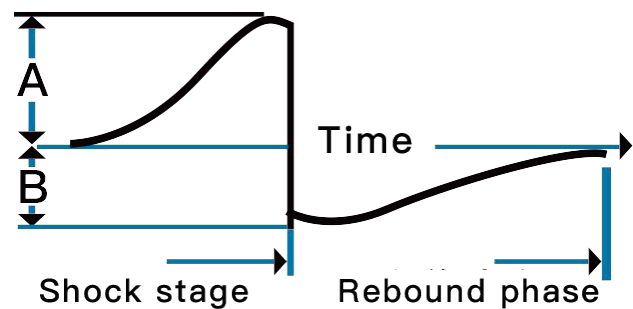

The output signal diagram of the impact device is shown in the right figure.



## 4.Preparation before Measurement

### 4.1Instrument Preparation

For newly purchased instruments, please check carefully with reference to the packing list. If the instruments and accessories are incomplete, please contact the manufacturer in time.



Before using the instrument for the first time or after a long time of non use, the instrument and impact device must be calibrated with random Leeb hardness block (i.e. user calibration)

When a host machine is equipped with multiple types of impact devices, each impact device only needs to be calibrated once, and there is no need to re-calibrate after replacing the impact device.

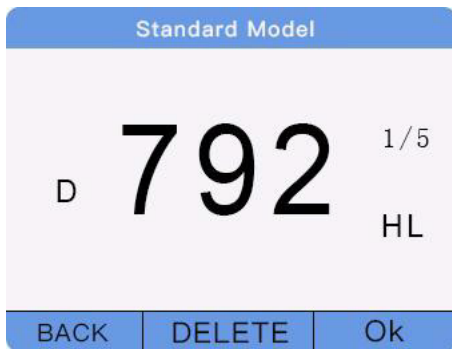
Press  and  hold the key while pressing the key to start the machine to enter the user calibration interface, as shown in the figure below:



Measure 5 points vertically downward on the calibrated Leeb hardness block. After measuring 5 points, the display will show the average value and "Ave" sign.

Press    the key to enter the standard value.

Press the OK key to complete the calibration or press the return key to cancel the calibration operation.

### 4.2Selection of Impact Device

Please refer to attached table 1 of this manual for the basis of selection.

## 4.Preparation before Measurement

### 4.3Preparation of measured working piece

The surface condition of the working piece shall meet the relevant requirements in Table 3.

In addition:

- The surface temperature of the working piece shall not be overheated and shall be less than 120 °C.
- The surface roughness of the working piece shall not be too large, otherwise it will cause measurement error. The measured surface of the working piece must show metallic luster, and be flat, smooth and free of oil stain.
- Requirements for working piece weight: no support is required for heavy samples weighing more than 5kg; The test piece with a weight of 2-5kg, the test piece with a overhanging part and the thin-walled test piece shall be supported by an object during the test, so as to avoid the deformation, bending and movement of the test piece caused by the impact force. For medium-sized working pieces, they must be placed on a flat and solid plane, and the samples must be placed absolutely stably without any shaking.
- Curved surface working piece: the test surface of the working piece is preferably flat. When the curvature radius  $r$  of the measured surface is less than 30mm (D, DC, D + 15, C, e, DL impact device) and less than 50mm (g impact device), small support ring or special-shaped support ring shall be used during the test.

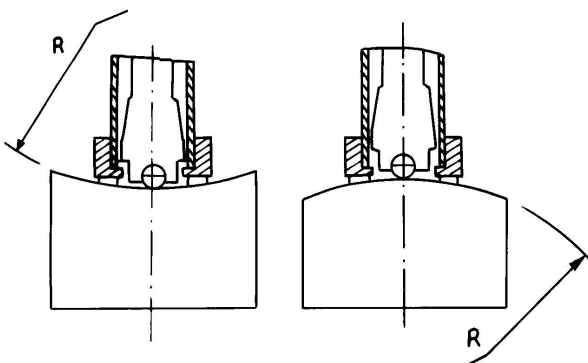

- The workpiece shall have sufficient thickness, and the minimum thickness of the workpiece shall comply with the provisions of Table 3.

## 4.Preparation before Measurement

- For workpieces with surface hardening layer, the depth of hardening layer shall comply with the provisions of Table 3.
- Coupling: light workpieces must be closely coupled with solid supports, the two coupling surfaces must be flat and smooth, the amount of coupling agent should not be too much, and the test direction must be perpendicular to the coupling plane; When the workpiece is a large-area plate, long rod and curved part, even if the weight and thickness are large, it may still cause deformation and instability of the test piece, resulting in inaccurate test values. Therefore, it shall be reinforced or supported on the back of the test point.
- The magnetism of the workpiece itself shall be less than 30 Gauss.

## 5.Measurement Method

**Note:** the value of random hardness block is measured vertically downward on it for 5 times with a calibrated Leeb hardness tester, and the arithmetic mean value is taken as the hardness value of random hardness block. If the value exceeds the standard, the user calibration function can be used for calibration.

Before measurement, the instrument can be tested with random hardness block, and the indication error and repeatability shall not be greater than those specified in Table 2-1.

### 5.1Startup

insert the impact device plug into the impact device socket of the instrument.

press  the key for a long time. At this time, the power is turned on, and the instrument starts and enters the measurement state.

## 5.Measurement Method

### 5.2Loading



- Push down the loading sleeve to lock the impact device ; For DC type impact device, the loading rod can be sucked on the surface of the sample, and the DC type impact device can be inserted into the loading rod until the stop position. At this time, the loading is completed.

### 5.3Positioning

Press the supporting ring of the impact device tightly on the sample surface according to the selected measurement direction, and the impact direction shall be perpendicular to the test surface;

### 5.4Measurement

- press the release button on the upper part of the impact device for measurement. At this time, the sample, impact device and operator shall be stable, and the force direction shall pass through the axis of the impact device. Each time a measurement is completed, the display screen will display the measured value; The count of impact times increases by 1; If the measurement range is exceeded, the buzzer will sound for a long time; After reaching the set number of shocks, the buzzer will give two short beeps. After waiting for 2 seconds, the buzzer will give one short beep to display the average value.

## 5.Measurement Method

- Each measuring part of the sample is generally tested for many times. The data dispersion shall not exceed  $\pm 15\%$  of the average value.
- The distance between any two indentations or the distance between the center of any indentation and the edge of the sample shall comply with the provisions in the following table.
- For specific materials, in order to accurately convert the Leeb hardness value into other hardness values, comparative tests must be conducted to obtain the corresponding conversion relationship. The method is: use the qualified Leeb hardness tester and the corresponding hardness tester to test on the same sample respectively. For each hardness value, measure the Leeb hardness of five points evenly distributed around more than three hardness indentations to be converted, and use the average value of Leeb hardness and the average value of corresponding hardness as the corresponding values to make the hardness comparison curve. The comparison curve shall include at least three groups of corresponding data.

Table 5-1

Impact Device Type	Distance between two indentation centers	Distance between indentation center and specimen edge
	Not less than	Not less than
D; DC	3mm	5mm
DL	3mm	5mm
D+15	3mm	5mm
G	4mm	8mm
E	3mm	5mm
C	2mm	4mm

### 5.5Reading Measured Values

- Use the average value of multiple effective test points as one Leeb hardness test data.
- The hardness value is shown in front of the Richter hardness symbol HL, and the type of

## 5.Measurement Method



impact device is shown in front of the value.

### 5.6Special Tips

- Under normal conditions, the current measured value cannot be stored when the set impact times are not reached.
- Only D-type and DC type impact devices have strength measurement function, so when using other types of impact devices, it will not be possible to switch to strength measurement function. If D / DC type impact device is used and set as strength measurement mode.
- Not all materials can be converted to all hardness systems.

## 6.Instrument Operation

### 6.1Instrument Startup and Shutdown

- 1)Insert the impact device plug into the instrument impact device socket;
- 2)Press  the key for a long time. With the startup beep, the instrument will automatically detect the type of impact device and display it. At this time, please pay attention to whether it is correct, and then enter the main measurement display interface. At this time, the parameters of the instrument are the parameters used before the last shutdown;
- 3)In the power on state, the  long key can realize the shutdown operation.

### 6.2Material Setting

Press  the key to change the material setting. Each press will cycle among the materials and change the hardness system to Richter scale, so set the material first and then the

## 6. Instrument Operation

hardness system.

### 6.3 Hardness Test Setup



The  key can be switched and selected in various hardness systems. The hardness systems supported by the instrument include HL, HV, Hb, HRA, HRC, HS and HRB.

### 6.4 Setting of Impact Direction

Press  the key to change the impact direction setting.

### 6.5 Average Frequency Setting

The average number of times can be modified in the range of 1 ~ 32 times.

Press  the key to enter the "impact times" setting state, and frame select to display the current impact times. Press   the key and the key to adjust the impact times to a predetermined value.

In the setting state of "impact times", press  to exit the setting.

### 6.6 Storage Function

#### 6.6.1 Storing Test Results

Up to 100 data groups can be stored in the instrument.

After hardness measurement, you can directly press  the key to save the current data group into the instrument; The storage operation is valid only after the average value is displayed, and can only be saved once. If the measurement is not finished (the average value is not displayed), the data cannot be saved.

During data storage, the storage icon on the display flashes, indicating that storage is in progress.

When storing values, if the total number of records in the current file has reached 100, the

## 6. Instrument Operation

instrument will automatically overwrite the 100th group.

### 6.7 Statistical Function

This instrument has a statistical table for viewing each measurement, which can more intuitively view each measurement value.

Press  the key to enter the statistics interface and view the statistics table of each measured value within the set number of times.

### 6.8 Shock Waveform Display Function

The instrument has the function of viewing the impact waveform display of each measurement.

Press  the key to view the display of the impact waveform. From the impact waveform, you can judge the effectiveness of the test and the working state of the impact device, such as whether the probe is worn and whether there is dirt in the casing.

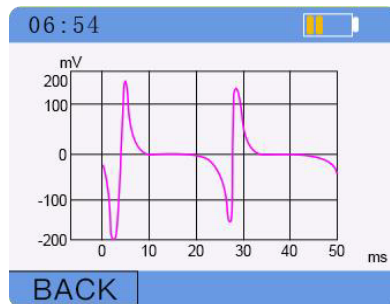

### 6.9 Menu Functions



Press  the key to set the test conditions, storage management, system setting and view the product information of the instrument.





## 6. Instrument Operation

### 6.9.1 Test Condition Setting



#### 6.9.1.1 Setting of Impact Device

Press  the key, select "test condition setting" through , press the OK key to set the impact device, press the OK key to select the impact device model, and select auto as the automatic impact device. If you like or the machine cannot be recognized, you can manually select the impact device of D / DC / DL / D + 15 / C / G / E model respectively.



#### 6.9.1.2 Material Setting

Press  the key, select "test condition setting" through   the key, and press the confirm key to enter the material setting interface. In the hardness mode, you can select the options of "steel and cast steel", "alloy tool steel", "cast aluminum alloy", "gray cast iron", "nodular cast iron", "stainless steel", "copper zinc alloy", "copper tin alloy" and "pure copper". In the strength mode, the options of "carbon steel", "chromium steel", "chromium vanadium steel", "chromium nickel steel", "chromium molybdenum steel", "chromium nickel molybdenum steel", "chromium manganese silicon steel", "ultra-high strength steel" and "stainless steel" are available.

#### 6.9.1.3 Times Setting

Press  the key and select "test condition setting" through   the key. After pressing the confirm key, you can select the "times setting" interface, which can select the times of measuring and calculating the average value. The selection range of times is 1-32 times.



#### 6.9.1.4 Setting Limits

Press the  key, select "test condition setting" through   the key, and press the OK key to select the "set limit" interface. After entering the set limit, you can set the required upper and lower limits of the measured values. (refer to 5.9.2.3 if an alarm is required when exceeding the limit)

## 6.Instrument Operation





### 6.9.1.5 Hardness / Strength Setting

Press  the key, select "test condition setting" through   the key, press the confirm key, you can select the "hardness / strength" interface, enter the interface, and you can select whether to measure hardness or strength.

### 6.9.2Storage Management

The instrument can store up to 100 groups of hardness / strength measurement data (impact times 32 ~ 1). Each group of data includes single measurement value, average value, impact direction, times, material, hardness system and impact device model.

Press  the key, select "storage management" through   the key, press the OK key to enter the data interface, select the measurement data, and press the OK key to view the relevant measurement data.

When the instrument stores 100 groups of data, the measured data will not be saved, and the storage flag on the interface will turn red and flash three times to remind that the data has not been saved. To save data, delete the data before saving.

Delete stored data: in the storage management interface, press  the key to delete all data.



### 6.9.3System Setting

The instrument can personalize the system, such as automatic storage, key sound, warning switch, LCD brightness, automatic shutdown, time setting, language and other



## 6. Instrument Operation

options.



### 6.9.3.1 Automatic Storage

Press  the key, select "system setting" through   the key, and press the confirm key to enter the system setting interface. Select "automatic storage" and press the confirm key. There is a check mark behind it, indicating that the automatic storage function has been started. If you want to cancel, press the OK key again, and the check box disappears.

### 6.9.3.2 Key Sound





Press  the key, select "system setting" through   the key, and press the confirm key to enter the system setting interface. Select "key sound" and press the OK key. There is a check mark behind it, indicating that the key sound function has been started. If you want to cancel, press the OK key again, and the check box disappears.

### 6.9.3.3 Warning Switch

Press  the key, select "system setting" through   the key, and press the confirm key to enter the system setting interface. Select the "warning switch" and press the OK key, followed by a check, indicating that the warning alarm function has been started. If you want to cancel, press the OK key again, and the check box disappears.



If the warning switch is selected to turn on, in the main interface, when the measured value exceeds the upper and lower limits (refer to 6.9.1.4 for the upper and lower limits), the color of the test value turns pink.

### 6.9.3.4 LCD Brightness







Press  the key, select "system setting" through   the key, press the OK key to enter the system setting interface, select "LCD brightness" and press the OK key to enter the LCD brightness interface, press   to display the brightness, and the number "5" is the brightest.

## 6. Instrument Operation





### 6.9.3.5 Automatic shutdown

Press  the key, select "system setting" through   the key, press the OK key to enter the system setting interface, select "automatic shutdown" and press the OK key to select the time of automatic shutdown. When the instrument is not operated, the instrument will shut down at the selected time point (2 minutes / 5 minutes / 10 minutes).



### 6.9.3.6 Time setting

Press  the key, select "system setting" through   the key, press the confirm key to enter the system setting interface, select "time setting" and press   the OK key. After entering the time setting interface, select the position to be set, press the resize key, and then press   the OK key to exit.

### 6.9.3.7 Language

Press  the key, select "system setting" through   the key, press the OK key to enter the system setting interface, select "language" and press the OK key to enter the language setting interface, press to select Chinese / English, and press   the OK key to exit.

### 6.9.4 Product Information

Press  the key, select "product information" through   the key, and press the confirm key to view the relevant information of the instrument.

## 7. Maintenance and Repair

### 7.1 Maintenance of Impact Device

- After 1000-2000 times of use, clean the conduit and impact body of the impact device with a nylon brush. When cleaning the conduit, first unscrew the support ring, then take out the impact body, screw the nylon brush counterclockwise into the tube, pull it out to the end, repeat this for 5 times, and then install the impact body and support ring;
- Release the impact device after use;
- It is forbidden to use various lubricants in the impact device.

### 7.2 Precautions for Instrument Use

- Avoid strong vibration of the instrument;
- Avoid placing the instrument in too humid environment;
- When plugging in and out the probe, hold the movable jacket and force along the axis. Do not rotate the probe to avoid damaging the cable core of the probe.
- The attachment of oil and dust will gradually age and fracture the probe wire. After use, remove the dirt on the cable.

### 7.3 Instrument Maintenance

- When the standard Rockwell hardness block is used for verification, if the error is greater than 2HRC, the ball joint may be worn and invalid, and the ball joint or impact device shall be replaced.
- In case of other abnormal phenomena of the hardness tester, please do not disassemble or adjust any fixed assembly parts. After filling in the warranty card, submit it to the maintenance department of our company to implement the warranty regulations.

## 8. Appendix: Vibration Standards

Table 1

Hardness Scale	Impact Device					
	D/DC	D+15	C	G	E	DL
HRC	17.9~68.5	19.3~67.9	20.0~69.5		22.4~70.7	20.6~68.2
HRB	59.6~99.6			47.7~99.9		37.0~99.9
HRA	59.1~85.8				61.7~88.0	
HB	127~651	80~638	80~683	90~646	83~663	81~646
HV	83~976	80~937	80~996		84~1042	80~950
HS	32.2~99.5	33.3~99.3	31.8~102.1		35.8~102.6	30.6~96.8
HB	143~650					
HRC	20.4~67.1	19.8~68.2	20.7~68.2		22.6~70.2	
HV	80~898	80~935	100~941		82~1009	
HRB	46.5~101.7					
HB	85~655					
HV	85~802					
HRC						
HB	93~334			92~326		
HV						
HRC						
HB	131~387			127~364		
HV						
HB	19~164		23~210	32~168		
HRB	23.8~84.6		22.7~85.0	23.8~85.5		
HB	40~173					
HRB	13.5~95.3					
HB	60~290					
HB	45~315					

## 8. Appendix: Vibration Standards

Table 2

No.	Material	HLD	$\sigma_b$ (MPa)
1	C mild steel	350~522	374~780
2	C High carbon steel	500~710	737~1670
3	Cr	500~730	707~1829
4	CrV	500~750	704~1980
5	CrNi	500~750	763~2007
6	CrMo	500~738	721~1875
7	CrNiMo	540~738	844~1933
8	CrMnSi	500~750	755~1993
9	SSST	630~800	1180~2652
10	SST	500~710	703~1676

Table 3

Special shaped impact device	DC(D)/DL	D+15	C	G	E
Impact energy	11mJ	11mJ	2.7mJ	90mJ	11mJ
Impactor mass	5.5g/7.2g	7.8g	3.0g	20.0g	5.5g
Ball joint hardness:	1600HV	1600HV	1600HV	1600HV	5000HV
Ball joint diameter:	3mm	3mm	3mm	5mm	3mm
Ball joint material:	Tungsten carbide	Tungsten carbide	Tungsten carbide	Tungsten carbide	diamond
Impact device diameter:	20mm	20mm	20mm	30mm	20mm
Length of impact device:	86(147)/75mm	162mm	141mm	254mm	155mm
Weight of impact device:	50g	80g	75g	250g	80g
Maximum hardness of test piece	940HV	940HV	1000HV	650HB	1200HV
Average surface roughness of test piece Ra	1.6 $\mu$ m	1.6 $\mu$ m	0.4 $\mu$ m	6.3 $\mu$ m	1.6 $\mu$ m

## 8. Appendix: Vibration Standards

Minimum weight of test piece:	Direct measurement	>5kg	>5kg	>1.5kg	>15kg	>5kg
	Need stable support	2~5kg	2~5kg	0.5~1.5kg	5~15kg	2~5kg
	Dense coupling required	0.05~2kg	0.05~2kg	0.02~0.5kg	0.5~5kg	0.05~2kg
Minimum thickness of test piece Dense coupling		5mm	5mm	1mm	10mm	5mm
Minimum depth of hardened layer		≥0.8mm	≥0.8mm	≥0.2mm	≥1.2mm	≥0.8mm
Ball joint indentation size						
Hardness 300HV	Indentation diameter	0.54mm	0.54mm	0.38mm	1.03mm	0.54mm
	Indentation depth	24μm	24μm	12μm	53μm	24μm
Hardness 600HV	Indentation diameter	0.54mm	0.54mm	0.32mm	0.90mm	0.54mm
	Indentation depth	17μm	17μm	8μm	41μm	17μm
Hardness 800HV	Indentation diameter	0.35mm	0.35mm	0.35mm	-	0.35mm
	Indentation depth	10μm	10μm	7μm	-	10μm
Application field of impact device		DC type measuring hole or cylindrical cylinder; DL type measuring slender narrow groove or hole; Type D is used for routine measurement	D + 15 contact surface is fine and lengthened, which is suitable for measuring groove or concave surface	C-type impact force is small, with little damage to the measured surface and no damage to the hardened layer. It is suitable for measuring small light parts and hardened layer.	G-type measurement for heavy castings and forgings with rough surface	E-type measuring material with extremely high hardness

## 8.Appendix: Vibration Standards

Table 4

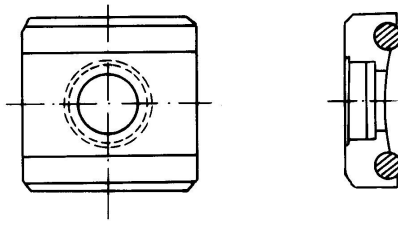
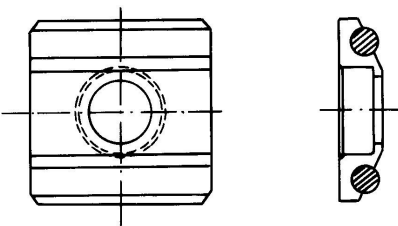
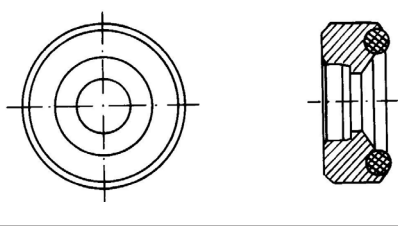
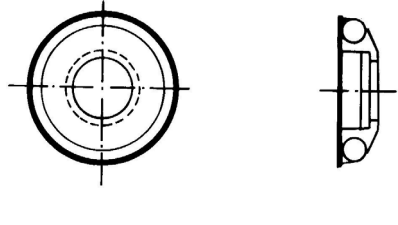
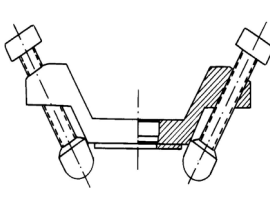
No.	Model	Diagram of special-shaped support ring	Remarks
1	Z10-15		Outer cylindrical surface R10~R15
2	Z14.5-30		Outer cylindrical surface R14.5~R30
3	Z25-50		Outer cylindrical surface R25~R50
4	HZ11-13		Inner cylindrical surface R11~R13
5	HZ12.5-17		Inner cylindrical surface R12.5~R17
6	HZ16.5-30		Inner cylindrical surface R16.5~R30
7	K10-15		Measuring outer sphere SR10~SR15
8	K14.5-30		Measuring outer sphere SR14.5~SR30
9	HK11-13		Measuring inner sphere SR11~SR13
10	HK12.5-17		Measuring inner sphere SR12.5~SR17
11	HK16.5-30		Measuring inner sphere SR16.5~SR30
12	UN		Outer cylindrical surface with adjustable radius R10~∞

## 9.Packing List

	Name	Qty	Note
Standard Accessories	Main unit	1	
	D impact device	1	
	Standard Test block	1	
	Brush	1	
	Supporting ring	1	
	AA battery	2	
	Documents	1	
	ABS suitcase	1	
Optional Accessories	Brush B		
	Special shaped impact device and support ring		G impact device
	software		See Schedule 3 and Schedule 4
	Cable	1	PC terminal
	Bluetooth printer	1	
	Printing cable	1	

**Note:** Due to transportation costs, dry batteries are not delivered by default.

## Mikrosize Distributors Worldwide

Coventry,UK /Warsaw,Poland/Burago di Molgora, Italy/Langgöns,Germany/  
Madrid, Spain/Istanbul,Turkey/Minsk,Belarus/Moscow , Russia /Sao Paulo, Brazil/  
Mexico City ,Mexico/Penang, Malaysia/Bangkok Thailand etc.....



---

### Anhui Mikrosize Precision Instrument Co.,Ltd

Factory Producing Add: N013 Shuiku Road Shatou, Changan Town, Dongguan, China.

International Trading Office: A-4035 RuiFeng Business Expo , Wuhu City, China.

Web: [www.mikrosize.com](http://www.mikrosize.com) Email: [mikrosize@mikrosize.com](mailto:mikrosize@mikrosize.com)

