



iPoli-2S-250A Auto Metallographic Grinding Polishing Machine

Instruction Manual



Anhui Mikrosize Precision Instrument Co.,Ltd

Add: A-4035 RuiFeng Business Expo, Wuhu City, China, 241000.

Web: www.mikrosize.com **Email:** mikrosize@mikrosize.com



Safety Caution

Before you install, use of this product, please read this manual carefully. And pay special attention to the content of the remind and advice, abide by the points for attention; In order to avoid damage to equipment, fire and personnel injury!

Check whether the input range of power supply voltage is consistent with the equipment before use

Whether the grounding of the equipment meets the requirements

Determine whether the surrounding environment meets the installation requirements

Follow the operating procedures

Remove the power when cleaning the equipment

Equipment failure, do not disassemble the equipment without permission, Professional maintenance should be requested, avoid electric shock.

Please keep the instruction

Contents

1.Foreword	1
2. Main Technology Parameters	2
3.Schematic diagram of the whole machine	2
4. Installation and precautions	4
5. Operating keyboard and display instructions	6
6. Operation instructions and precautions.....	7
7. Simple trouble shooting	13
8. Packing List	14

1. Foreword

The iPoli-2S-250A automatic polishing machine is a double disk desktop, which is based on international standard and adopts the new generation of high precision and automatic polishing equipment manufactured by international advanced technology.

Advantage of this machine: The rotary direction of the grinding wheel can be arbitrarily chosen, and the polishing disc can be replaced quickly. Multi-sample clamping device and pneumatic single point loading. The machine adopts the advanced microprocessor control system, so that the speed of the polishing disc and the grinding head can be adjusted without grade, Setting of sample preparation pressure and time is intuitive and convenient. Only need to replace the grinding wheel or sandpaper and the fabric can complete the grinding and polishing process. This machine presents a broader applicability. It has the characteristics of stable rotation, safe and reliable, low noise and the use of casting aluminum base added the rigidity of grinding.

The machine is equipped with water cooling system, which can be used to cool the sample during grinding, so as to prevent the destruction of the metallographic tissue caused by the friction heat and wash away the abrasive particle at any time. With the fiberglass shell and stainless steel standard parts, the appearance is more beautiful and generous, at the same time improve the anti-corrosion, anti-rust property and easy to clean.

It is suitable for automatic preparation of rough grinding, fine grinding, coarse polishing and fine polishing process of metallographic samples. It is an ideal equipment for enterprises, scientific research units and colleges and universities.

2. Main Technical Parameters

- Diameter of grinding disc: 250mm
- Grinding and polishing disc speed: 50-1000 r/min (infinite speed regulation) and 400/600/800/1000 r/min (four-stage constant speed)
- Grinding and Polishing Wheel Steering: Adjustable Forward and Reverse Selection
- Speed of polishing head: 5-150 r/min (infinite speed control)
- Quantity of samples prepared: 6
- Loading range: 0-0.7Mpa adjustable, factory parameters set to less than 0.2Mpa
- Sample preparation time: 0-3000S
- Sample diameter: 30mm
- Input voltage: single phase,AC220V 50Hz

3. Schematic Diagram Of The Whole Machine



3. Schematic Diagram Of The Whole Machine

Description of each part function

The polishing Head:Internal mechanical electrical control,this is an important part of the whole machine

Polishing head control panel:Adjustment of pressure control parameters

polishing disc:Also known as "work disk", is an important part of the polishing test, which is used to keep the materials such as sandpaper and flannelette fixed on top.

Adjustable damping foot:Adjust the fuselage horizontal and stable

Holder: fix the sample, and 0-0.7Mpa pressure can be generated through the pressure head

Rotary water mouth:During the grinding process, the sample can be washed. Can be switched or turned according to need.

Water retaining ring:To prevent splashing during grinding.

Grinding control panel:To set the rotation speed and direction of work disk;control machine start, stop.



Please read the following terms and conditions carefully.

4. Installation and Precautions

4.1 Equipment must have a good grounding, must use three standard power outlet

4.2 Equipment should be installed on the workbench face of stable and no vibration, temperature 10°C to 30°C; Relative humidity < 85%, no corrosive gas and conductive dust around.

4.3 Open the box, remove the wrapping film on the whole machine and take out the attachment, put the whole machine and the base plate in a high position, then remove the two bolts from the bottom with the wrench and then move the whole machine to the workbench. Insert the end of the drain pipe into the drain joint on the back side of the device; Move the hoop to the middle of the joint with the drain pipe and tighten the screw to hold the drain. Screw the water inlet pipe into the water inlet tap and make the rubber pad contact with the water inlet tap and make sure it's seal well.

4.4 According to the condition of entering and drainage, the equipment should be installed and put in place, and 4 adjustable cushioning MATS will be adjusted to make the equipment base horizontal and stable.

4.5 The grinding disc can be changed quickly, to unload the grinding disc, holding the grinding disc with two hands, then gently lifting; Bring another grinding disc and keep it flat, visual grinding disc three hole of the piston rod and the piston rod of the basic corresponding drop, feel one hole corresponding, slight swing grinding disc to make the other two also corresponds to insert the disk flat, reoccupy hand press, make grinding disc and grinding base of the completely contact surface.

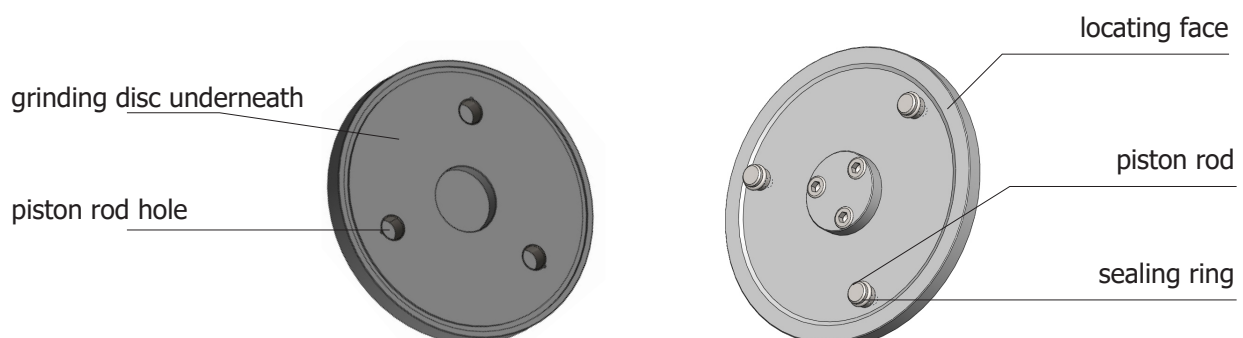

4. Installation and Precautions

4.6 Installation of metallographic sandpaper and polished fabric

Put the mill on the plane of the selling rub-up, will bring pressure sensitive adhesive metallographic sandpaper or polishing cloth paste on its visual sand paper or fabric with plate edge distance is almost the same, with a strong hand uniform pressure level make it binding.

4.7 Installation method of gripper

If the gripper needs to be replaced, use a wrench to loosen the two nuts on top of the gripper holder, and remove two sunk screws then remove the holder for replacement. After replacement, adjust the pressure head and the specimen fix sleeve hole to the concentric position, then tighten the two nuts

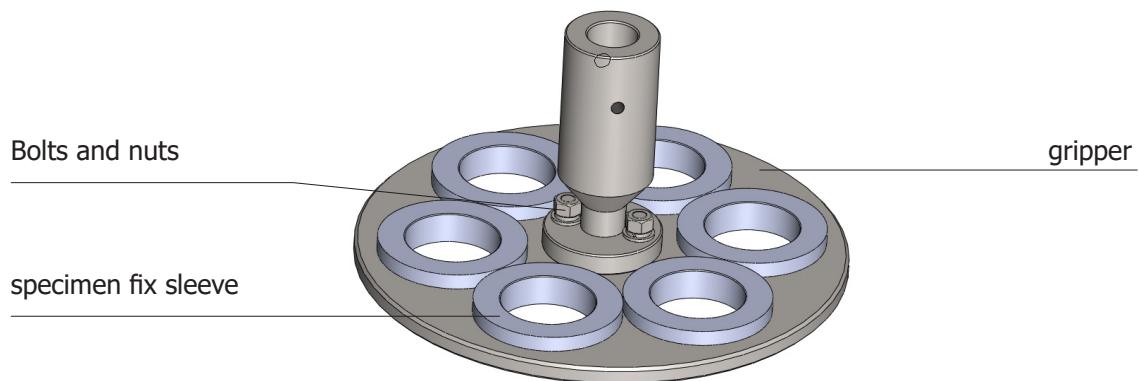

4.8 After switching off the tap water (use clean water), connect the inlet pipe to the tap water. Confirm that the water inlet switch on the equipment has been closed, and then switch on the tap water and the water inlet connection place should no leak

4.9 Place a container at the outlet pipe or drain the liquid waste to the outfall. Turn the water control knob in counterclockwise, open two rotary water mouths separately, check whether the inlet and drain are smooth, and the connecting parts cannot leak.

4.10 Insert the end of the air pipe into the quick change joint at the rear of the grinding head, and the other end insert to the gas source.



Note: the air source should meet the following requirements: the input pressure should be under or equal to 0.2mp; Must be filtered by filter, the filter core precision 40um

4. Installation and Precautions

4.11 Insert the power wire connector into the power cord interface at the rear of the grinding sea

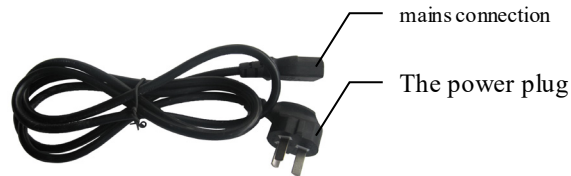

5. Operating keyboard and Display

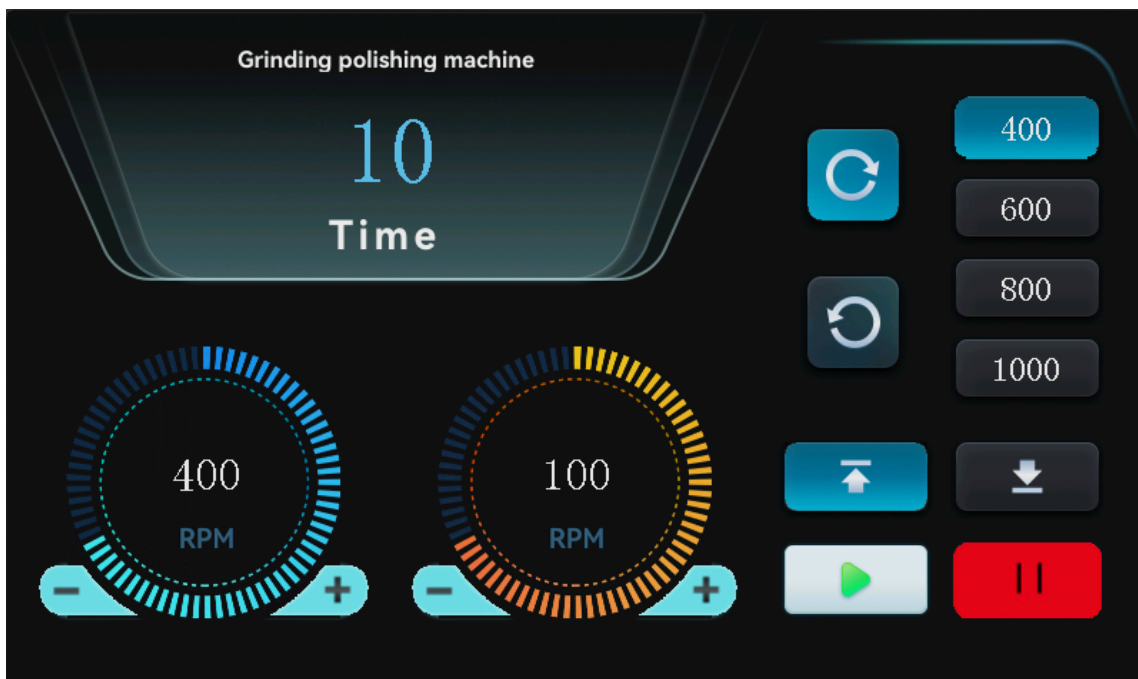

The LCD displays the sample grinding time, disc speed, grinding head speed, running direction, and the lifting and stopping of the four stage constant speed grinding head from top to bottom.



 Start button: start the running equipment.

 Stop button: stop operation button.

 Upward button of polishing head: raise the polishing head.

5. Operating keyboard and Display

 Lower button of polishing head: lower the polishing head.

  Positive and negative rotation keys: control the positive and negative rotation of the grinding disc.

Click the grinding time number to pop up the number keyboard, and you can set the grinding time setting range from 0 to 9999 seconds at will.

[+] Stepless speed regulation increases the speed. It can be adjusted when it is stopped or running.

[-] Reduce the speed during stepless speed regulation. It can be adjusted when it is stopped or running.

[Pressure gauge] When using the machine, the pressure gauge should be adjusted to 0.1 MPa at first, and then turn the knob (+) to gradually increase the pressure when the machine is running.

6. Operation Instructions and Precautions

This machine with double disk double speed, the right hand side for grinding disk 1, left hand side for grinding disk 2, when using two grinding disk rotates at the same time, please select double disk mode.

6.1 Insert the grinding-polishing seat power plug into the socket, press the power switch to "I" position, power in standby state; The display of the grinding head and the grinding seat shows the data before shutdown, and is in standby mode.

6.2 Application method of grinding

6.2.1 To use this machine for grinding, the specimen should do cutting for big piece or inlaying for irregular shape piece. If it is an interception sample of general equipment, it needs to be smoothed on the abrasive machine, and the water cooling is also used to

6. Operation Instructions and Precautions

prevent the structural change. It is recommended to use a dedicated cutting machine to intercept samples, which can be used for rough grinding directly.

6.2.2 Three steps of grinding, coarse grinding semi - grinding and fine grinding

1) Various parameters for grinding

Grinding parameters of grinding seat

process	abrasive grit size	RPM of grinding disc	To achieve
coarse grinding	240#-400#	50r/min-600 r/min	Remove the machining marks left by cutting
semi-grinding	600#-800#	50r/min-800r/min	Remove rough grinding marks
fine-grinding	1000#-2000#	50r/min-1000 r/min	Surface near mirror face without obvious grinding marks

Note: the grit size of the metallographic abrasive paper and the rotary speed should be selected according to the different requirements of the metallographic sample. When the sample requires general, the semi-fine grinding procedure can be omitted. When the sample request is higher, the grinding step should be increased appropriately.

Grinding parameters of grinding head

Sample QTY (pc)	Time(min)				pressure (N)	RPM of grripper (r/ min)
	240#	600#	1000#	1500#		
1-6	To smooth	2-3	2-3	2-3	20-50	10-80
1-3	To smooth	3-5	3-5	3	20-50	10-80

Note: 1) 1-6 clamps for samples in dia 45mm;
2) the parameters in the table are obtained according to the steel samples. When the sample is prepared with a high hardness, the upper limit of the parameters or the determination of the parameters according to the experience.

6. Operation Instructions and Precautions

2) Grinding method

a. Turn the lock hand up to vertical, then open the lift switch, grinding head up, turning the grinding head to the top of another grinding disc. Paste the grinding paper or fabric, and gently turn the grinding head back to the grinding disk to be used (The plastic retaining ring cannot be touched when falling), Turn the lock handle downward spiral of 45° , use hand to hold the head, (if turn the hand lock to the end, the head self weight may slightly lock the grinding head, causing the grinding head to stop falling or slow down). Then the head falls naturally; Slightly rotates the grinding head to make it at the appropriate place to the grinding disc, tighten the lock hand, and place the samples in the specimen fix sleeve holes.

b. Adjust the time, speed and pressure parameters of grinding head in standby mode (optional 180s, 50r/min, 30N, cannot be changed during working), Adjust the speed of the grinding seat (optional 300 the constant speed key), direction of turning. Rotate the rotary water nozzle to the place where the water can flow to the grinding disc and where the holder does not falls, press water inflow key, Slowly turn the water to adjust the knob to open the water nozzle, and adjust the flow of water to the water flow from the droplet to the column. Then press the start button, sample cylinder falling compact sample, grinding disc and clamping device working at the same time; Turn the rotating water nozzle close to the rubber head seat. At this time, observe whether the sample and sandpaper contact is good, no jumping, after normal, can be used for coarse grinding; After reaching the scheduled time, the device automatically stops, then turns the water nozzle back to the pre-start position. Rotate the hand lock up to the vertical to open the pneumatic switch, the grinding head rises, take out the sample and wash the surface to see if the grinding surface meets the requirements. If the requirements are not met, the above operation method shall continue to be grinded until the requirements are met.

6. Operation Instructions and Precautions

Note 1: The drainage should be free, so as to avoid the excess of water in the inner cavity and overflow the inner wall into the equipment, causing other machine parts to be damaged.

Note 2: If the machine stopped by press stop button, the equipment will be running at the same speed as before after restart.

Note 3: The parameters of the grinding base can be set at any time. The parameters of the grinding head need to be set when standby.

Note 4: The rotary nozzle should be removed before press the stop button and the starting key, otherwise the interference will be generated.

Note 5: During the first rough test, the pressure, the rotating speed should be reduced appropriately and the time will be prolonged.

To loosen the lock hand up to the vertical, rotate the grinding head, the selected semi-fine grinding or fine grinding of metallographic sandpaper into the grinding wheel, turning back the grinding head, the operation method is the same as the rough grinding. Adjust the parameters properly until the grinding requirements are met. This is the end of the grinding work.

6.3 The use of polishing

The two steps of polishing ,rough polishing and fine polishing

1.Various parameters for polishing use

Grinding parameters of grinding head

process	Polish particle size	The range of milling rotation	To achieve
rough polishing	W3-W5	50r/min-1000r/min	Remove fine grinding left by fine grinding and surface deformation layer
fine polishing	W0.5-W2	50r/min-1000r/min	The essence is thrown to a smooth, unscratched mirror

6. Operation Instructions and Precautions

Note: 1. The type of abrasive used for polishing agent, the size of the abrasive and the milling speed and the used fabric shall be selected according to the different requirements of the sample. The commonly used abrasive/polishing consumables are: grinding cream, polishing powder, spray polish and suspension. The abrasive has aluminium oxide, chromium oxide, diamond and colloidal silica. etc.
 2. When the sample request is higher, the polishing step should be increased appropriately.

Polishing parameters for grinding head

Specimen QTY (pcs)	time(min)		pressure (N)	RPM (r/min)
	diamond	Aluminum oxide		
1-6/1-3	1~3	3~5	10~20	300

Note: 1. The parameters in the table are obtained from wool-polyester or electrostatic flocking based on steel samples and polished fabrics; When preparing samples with high hardness, the upper limit of parameters or the determination of the experience.
 2. Use short polishing time whenever possible.

2)polishing method

a.Rough Polishing:Loosen the locking hand up to vertical, rotate the grinding head, and wipe off the brush to install the flocking cloth. Turn the water flow adjusting knob open the swivel water nozzle, so that the water drop to the flocking cloth, let the flocking cloth completely wet, close to the edge of the grinding disk, and spray with high efficiency diamond spray on the flocking cloth. Turn the polishing head back, turn lock hands downward spiral 45 ° use hand to hold the grinding head ,it will fall down naturally, slightly turn the polishing head make it at the appropriate position of the grinding disc, Tighten the lock hand down ; Put the sample in the sample sleeve holes.

b.Find Polishing:To loosen the locking hand up to the vertical, rotate the grinding head, remove the coarse flocking cloth, and rub the polishing disc to install the fine flocking cloth

6. Operation Instructions and Precautions

to install it; Turn back the grinding head and adjust the parameters properly. The operation method is the same as the rough polishing, polishing agent is used to polish the abrasive, until the sample meets the requirements of metallographic analysis. Finish the polishing work and turn off the power switch and system power. Turn off the water switch.

Note 1: Keep the polished fabric clean.



Note: The polishing pressure can not be too large, so as not to tear down the flocking cloth; The polished fabric should be pressed close to the polishing disk, and if the fabric comes off or the gripper is stuck, press the stop button quickly to stop the machine.

6.4 When the working temperature is below -10°C , the plastic parts should be especially handle carefully to avoid damage.

6.5 When the machine has abnormal sound, the machine should stop for inspection immediately.

6.6 After each operation, the cleaning and maintenance of the equipment should be done.



Note: No damaged sandpaper and polished fabric shall be used. Otherwise, grinding and polishing may damage the sample and the polishing disc

Note: Users can buy dedicated polishing fabric and metallographic sandpaper from our company.

7. Simple troubleshooting

Symptom	Trouble shooting
Turn on the power switch without display	<p>Check whether the power supply is available</p> <p>Whether the power cord and socket are in good contact</p> <p>Whether the insurance tube is broken</p>
Press start key device without reaction	<p>Whether the cable connection is good</p> <p>Whether the motor is damage</p>
Press the start key	<p>Whether the button is damaged or not</p> <p>The main control board is not working properly</p>
After a period of time, the use of the feeling disk is insufficient	<p>V Belt or synchronous belt wear, the belt should be replaced</p>

8. Packing List

No.	Descriptions	Specification	Quantity	Remarks
1	Grinding & Polishing Machine	iPoli-2S-250A	1 set	
2	Pressure-sensitive adhesive cloth	Φ250mm	2	Velour
3	Metallographic abrasive paper	Φ250mm	8	
4	Polishing disc	Φ250mm	2	
5	Clamping ring	Φ250mm	2	
6	Inlet water pipe		1	
7	Outlet water pipe		1	
8	Pressure tubing	Φ8mm	1	
9	Oil-Water Separator		1	
10	Dust Cover		2	
11	Power Cord		1	
12	Operating manual		1	
13	Packing list		1	
14	Certificate		1	

Mikrosize Distributors Worldwide

Coventry,UK /Warsaw,Poland/Burago di Molgora, Italy/Langgöns,Germany/
Madrid, Spain/Istanbul,Turkey/Minsk,Belarus/Moscow , Russia /Sao Paulo, Brazil/
Mexico City ,Mexico/Penang, Malaysia/Bangkok Thailand etc.....



Anhui Mikrosize Precision Instrument Co.,Ltd

Factory Producing Add: N013 Shuiku Road Shatou, Changan Town, Dongguan, China.

International Trading Office: A-4035 RuiFeng Business Expo , Wuhu City, China.

Web: www.mikrosize.com Email: mikrosize@mikrosize.com

